

Fig.1
(Prior Art)

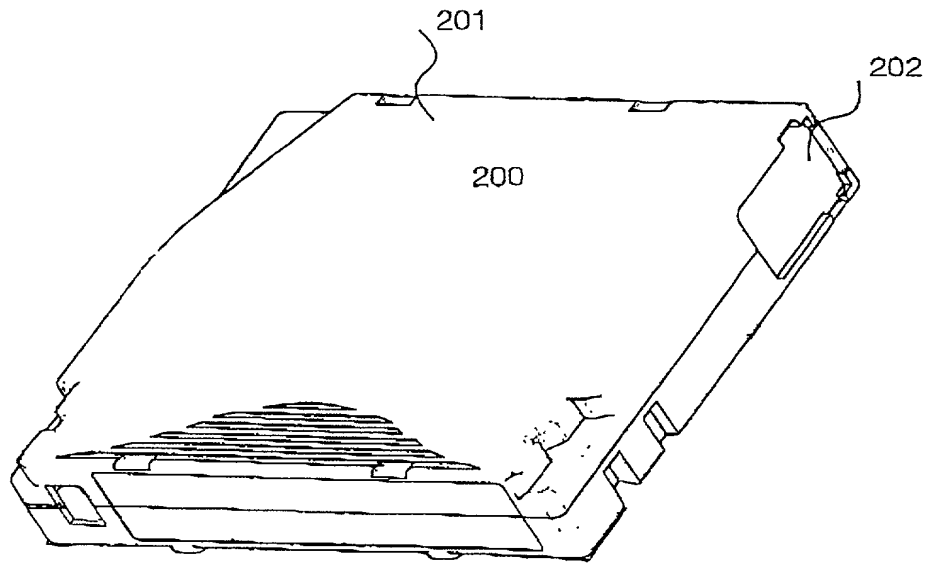

Fig. 2
(Prior Art)

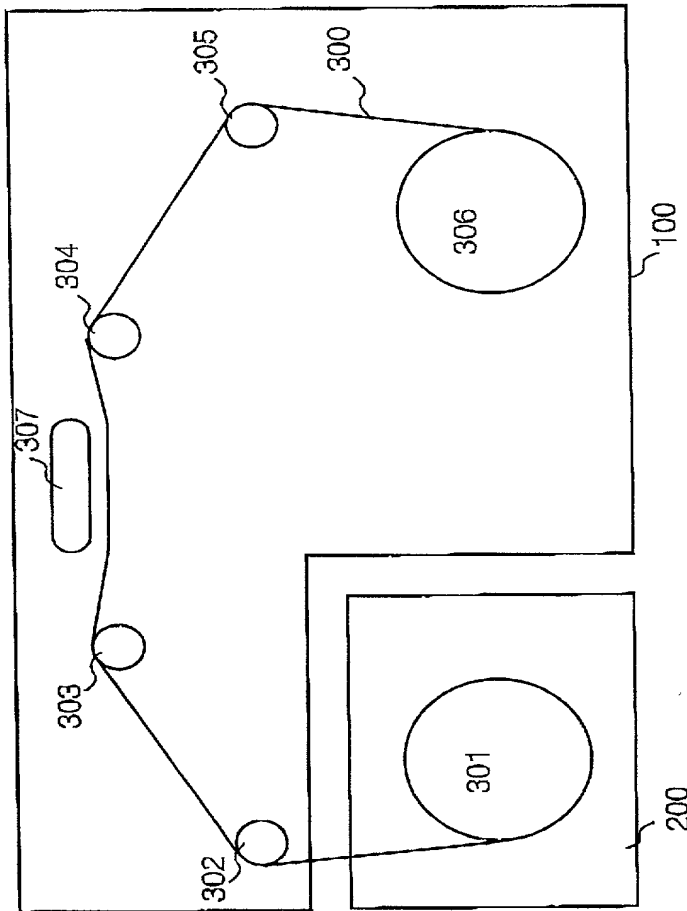

Fig. 3
(Prior Art)

FIG. 3

Patent Pending

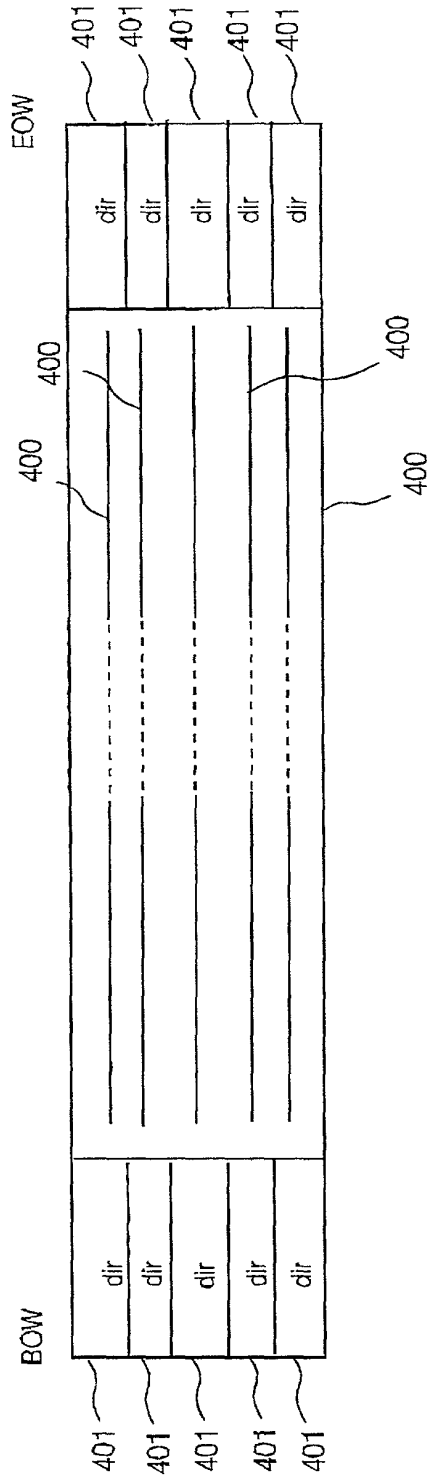

Fig.4
(Prior Art)

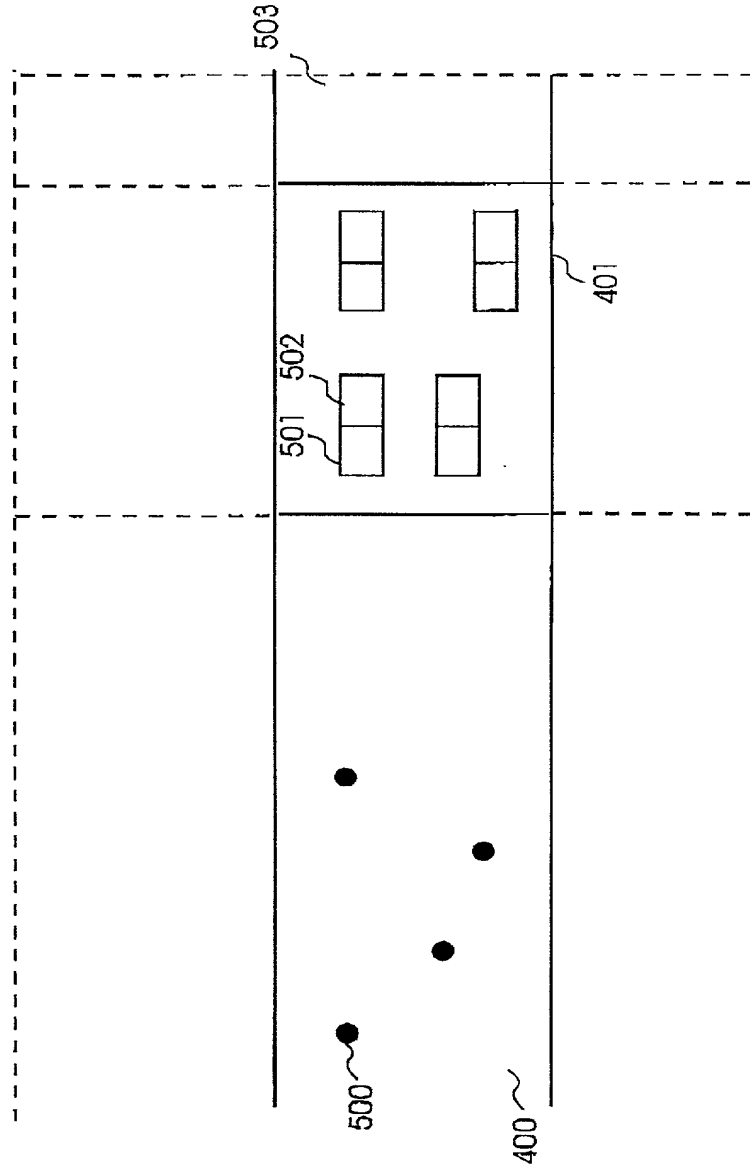

Fig. 5
(Prior Art)

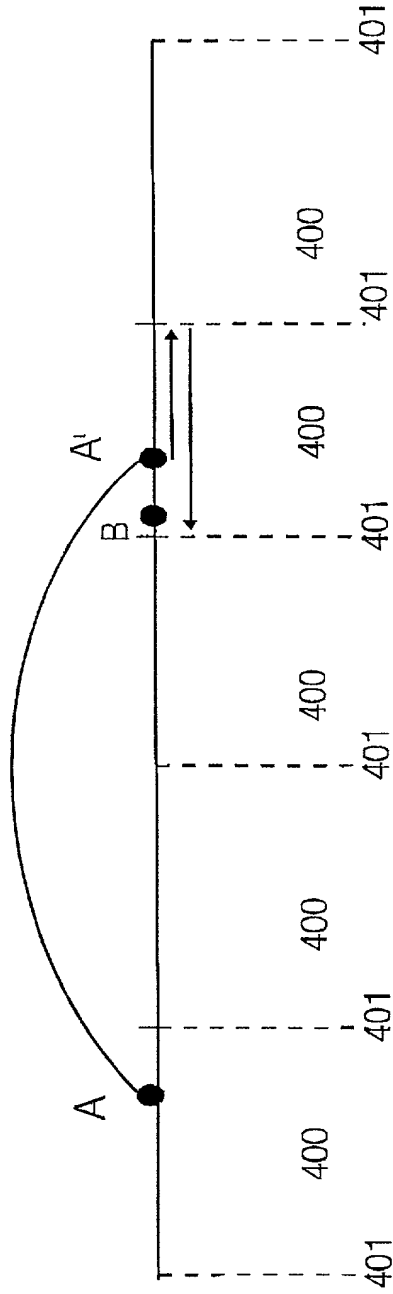

Fig.6
(Prior Art)

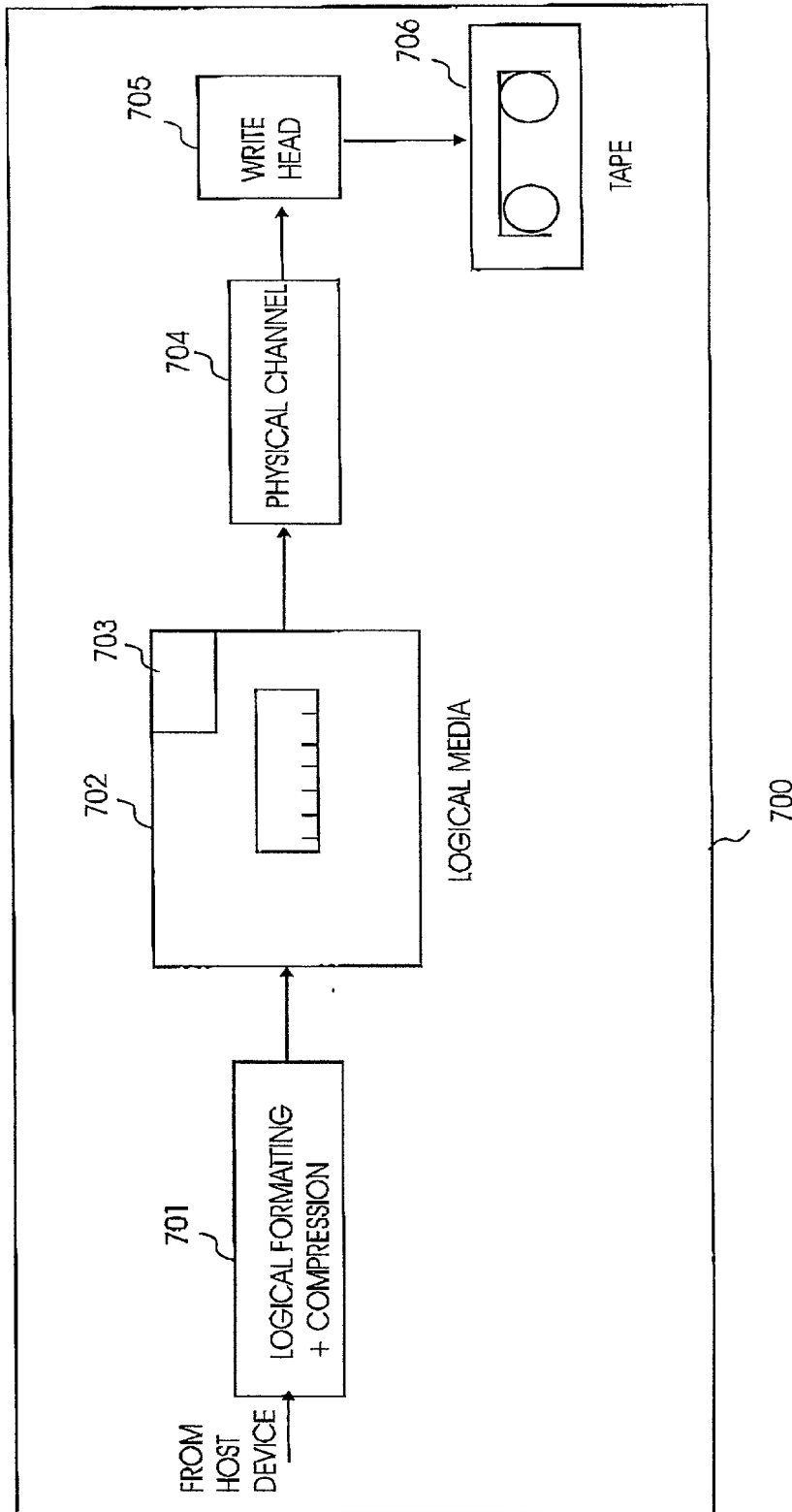

Fig.7

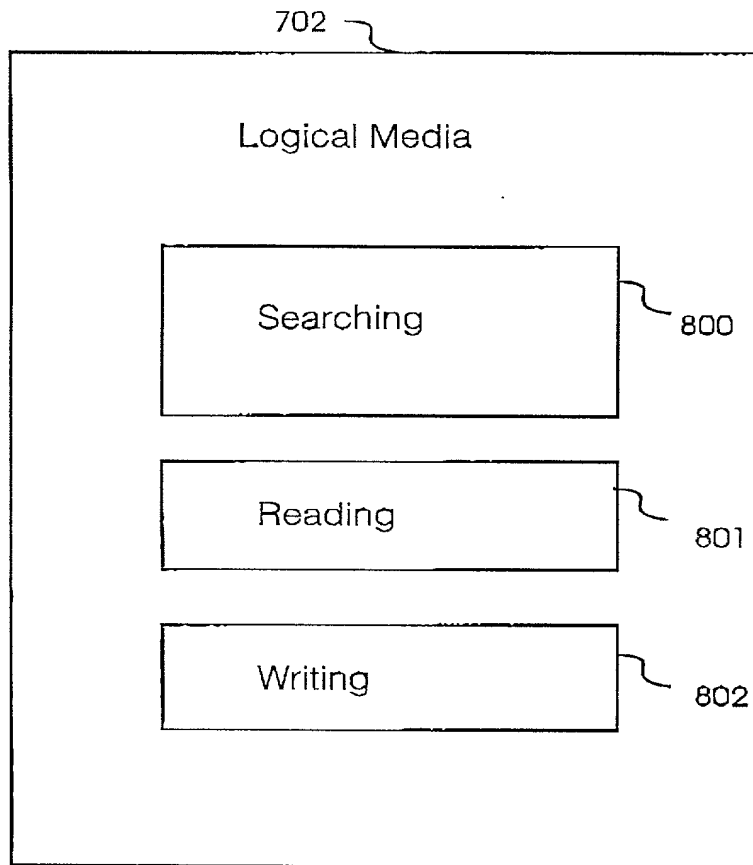

Fig. 8

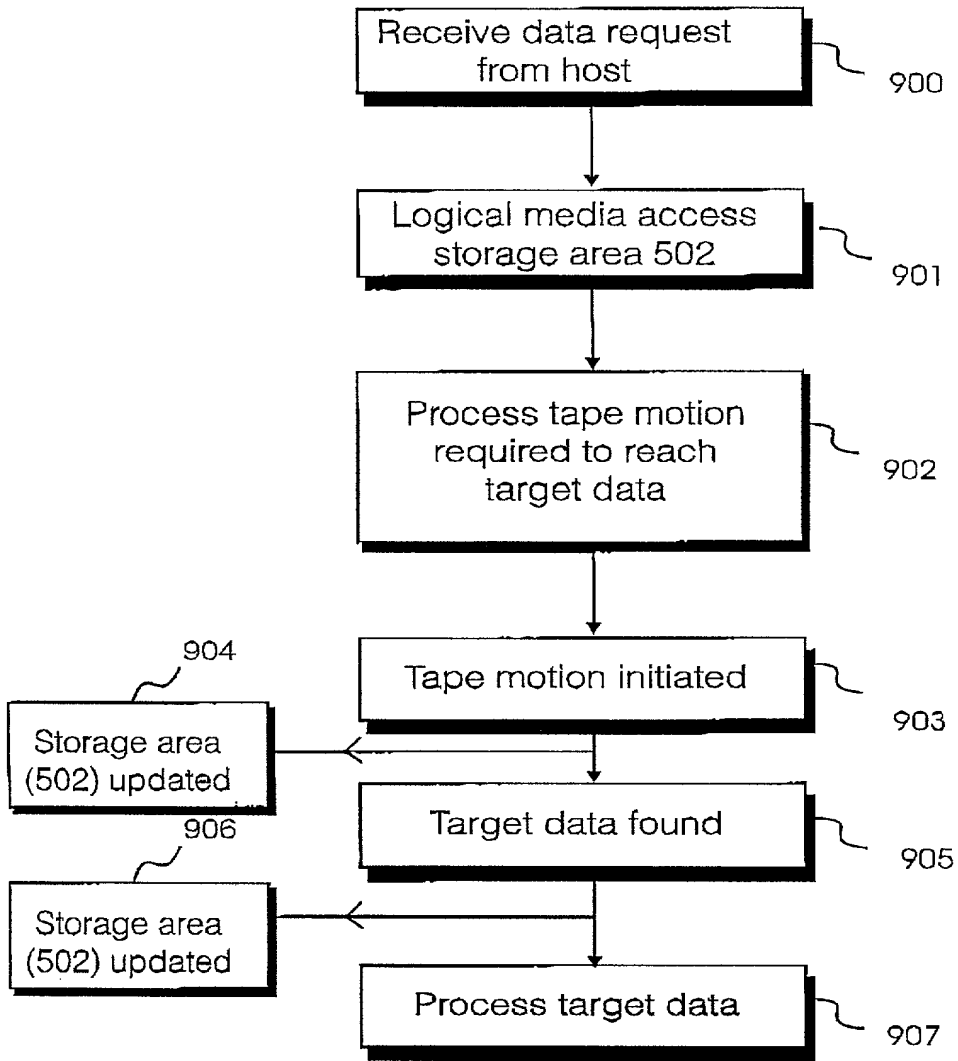

Fig. 9

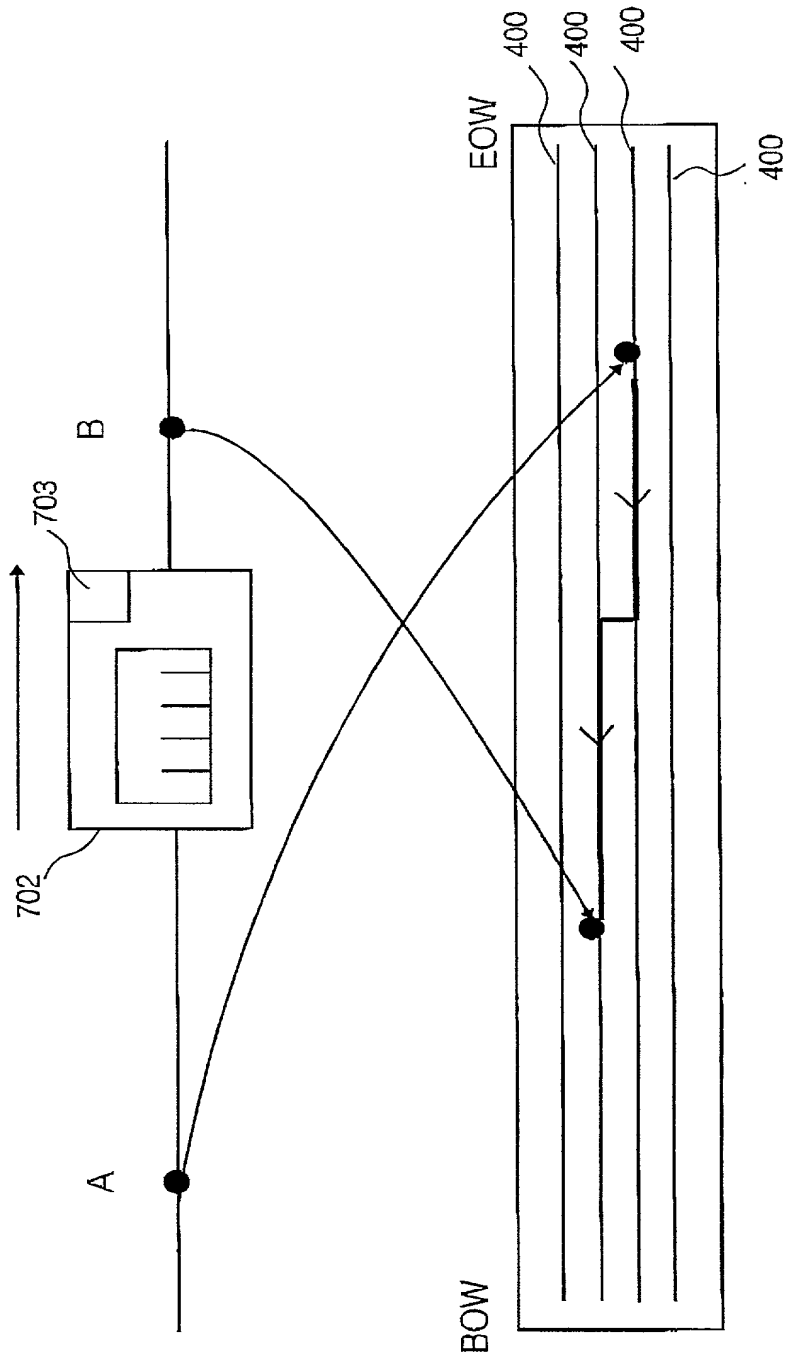

Fig.10

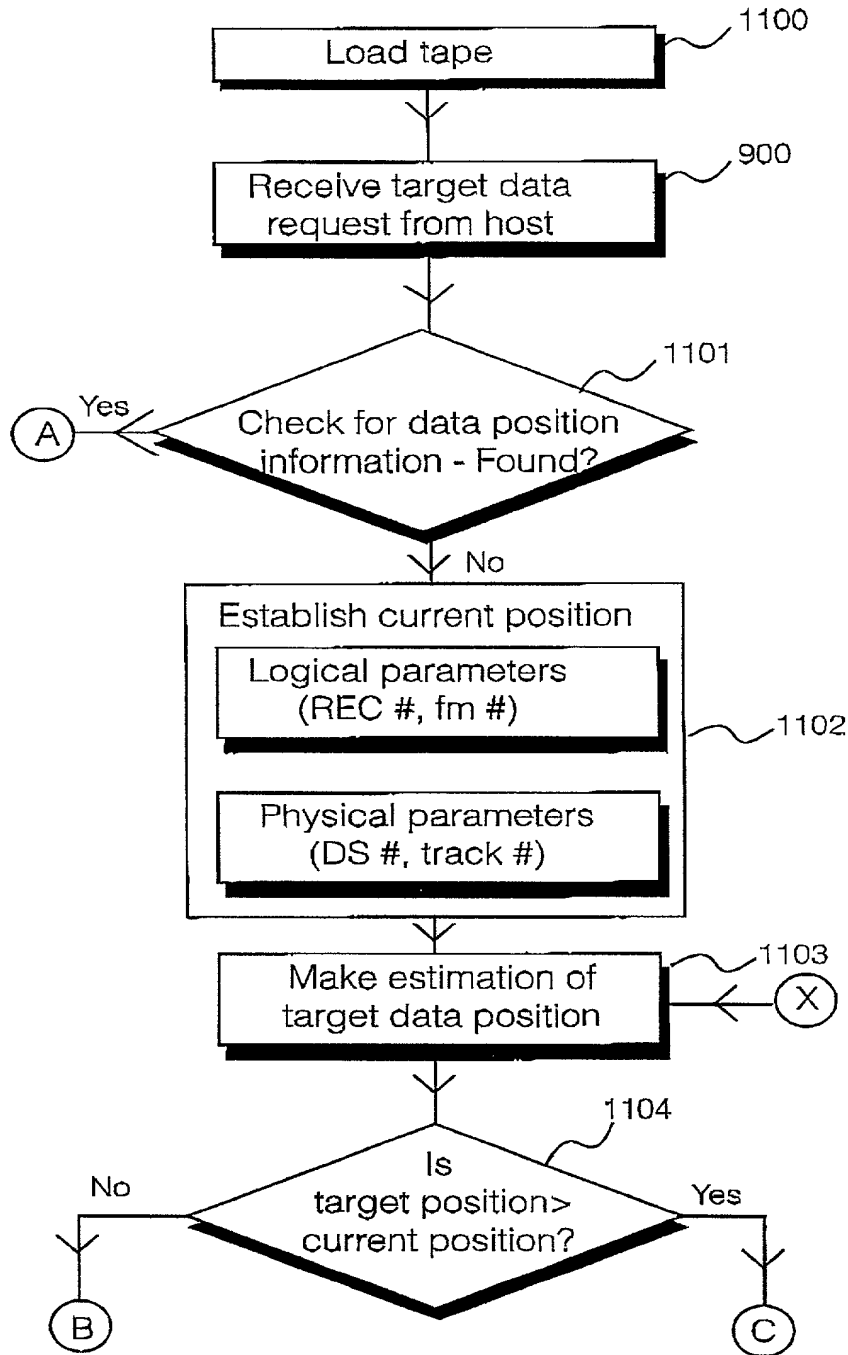

Fig. 11a

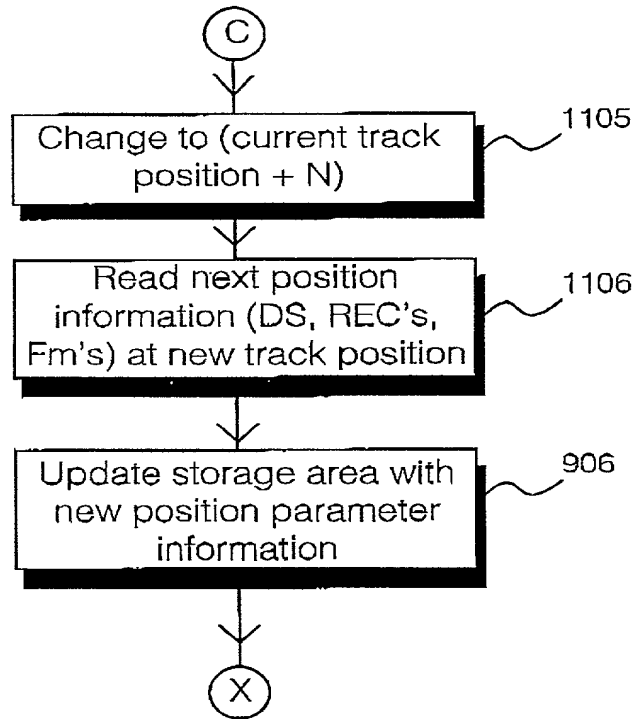

Fig. 11b

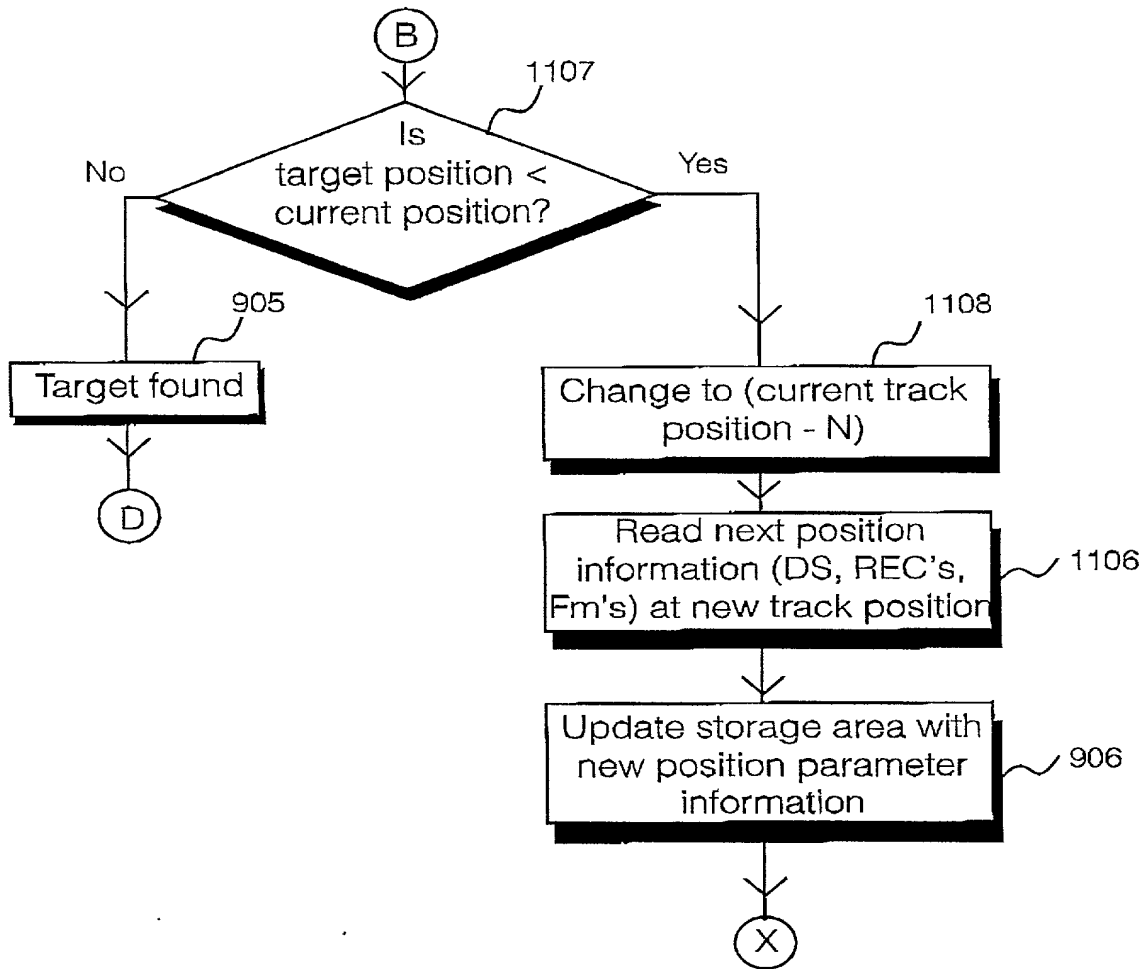

Fig. 11c

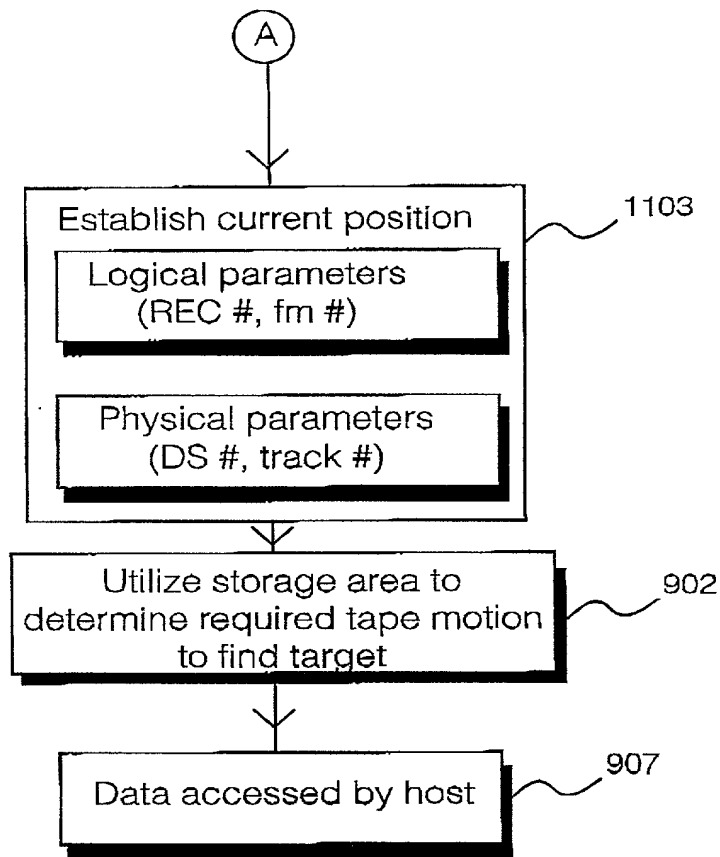

Fig. 11d

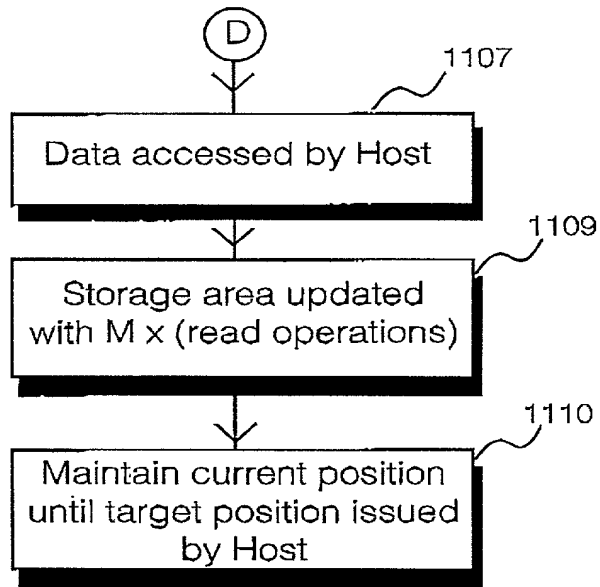

Fig. 11e

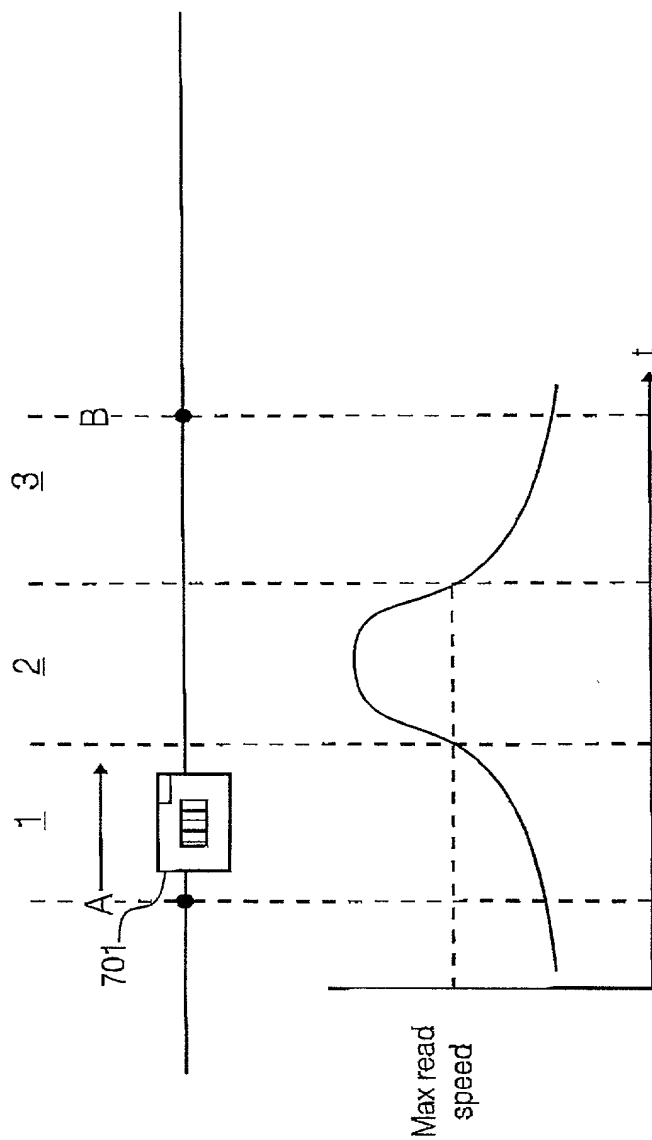

Fig. 12

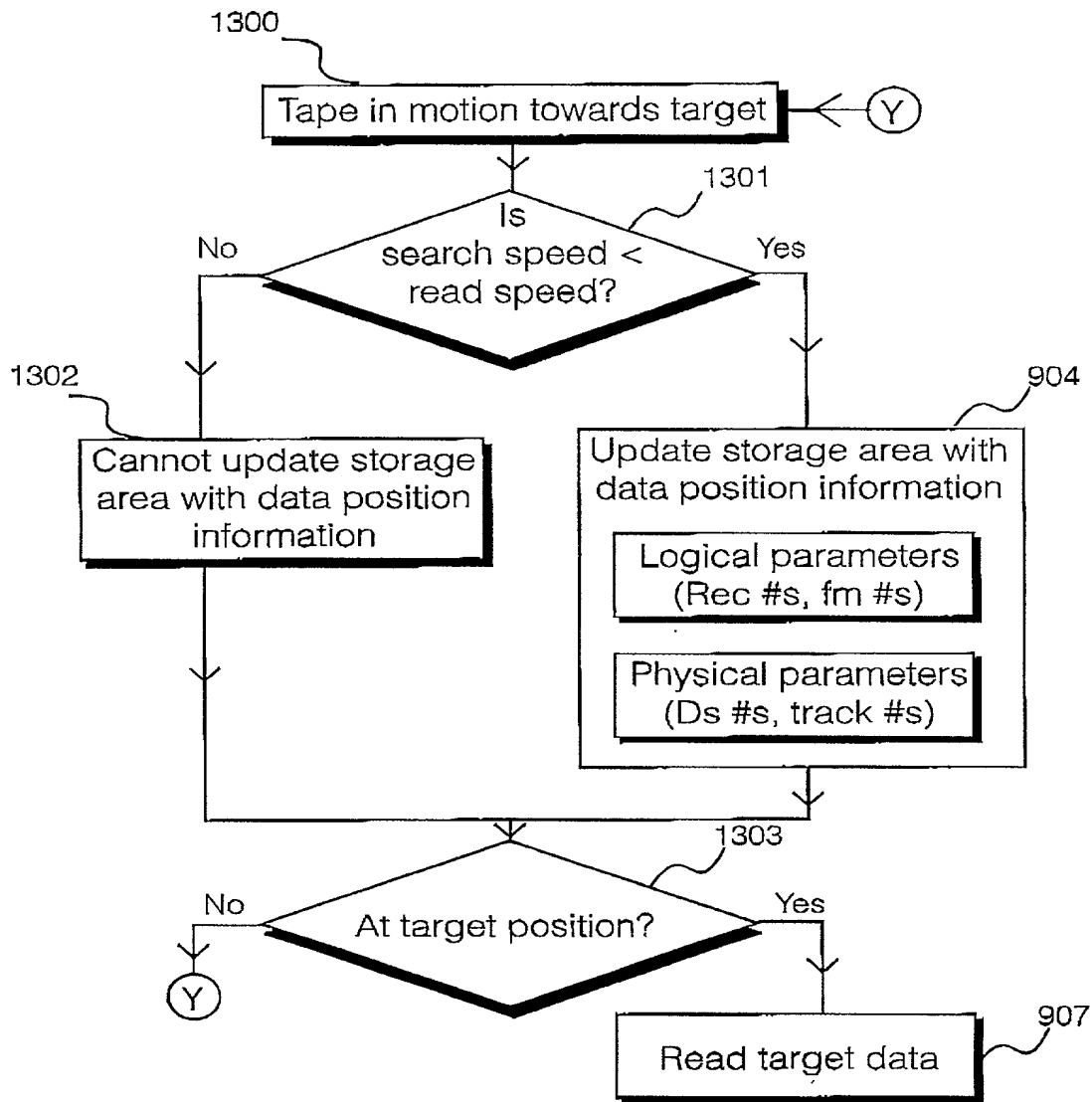

Fig. 13

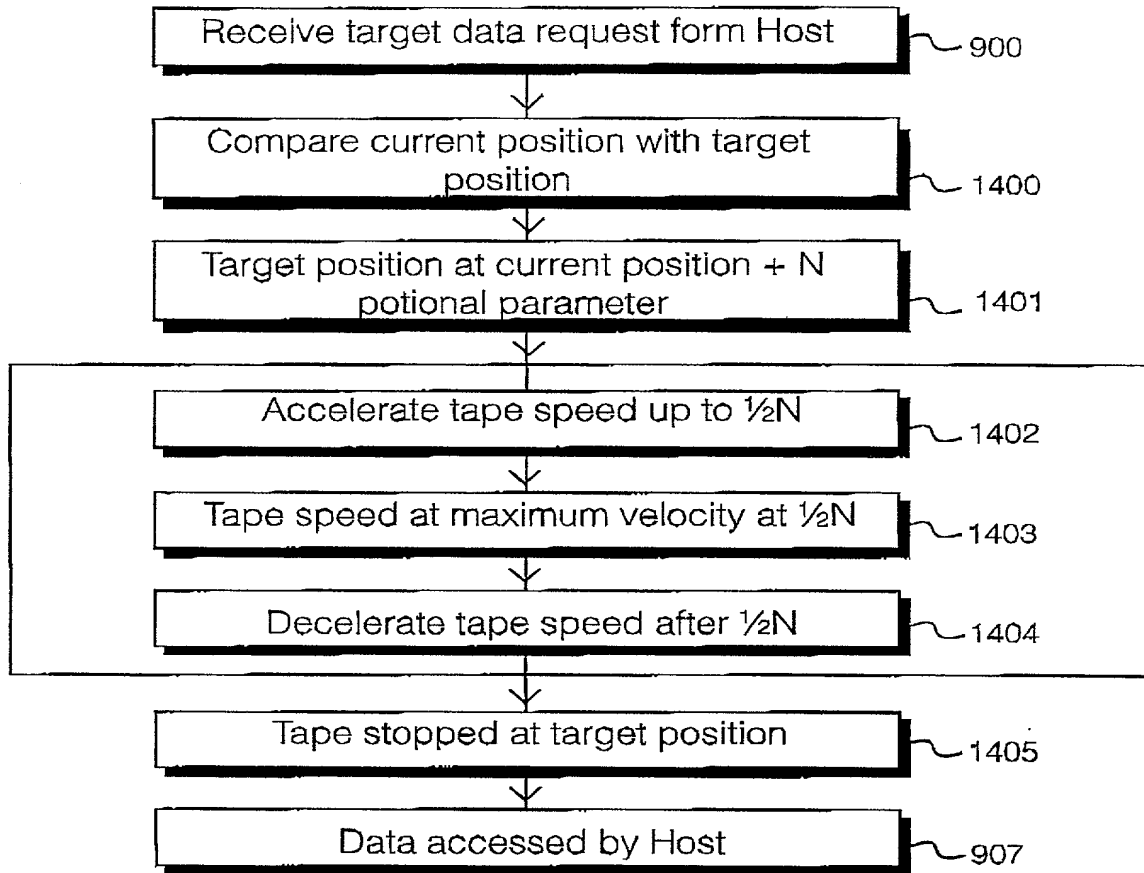

Fig. 14

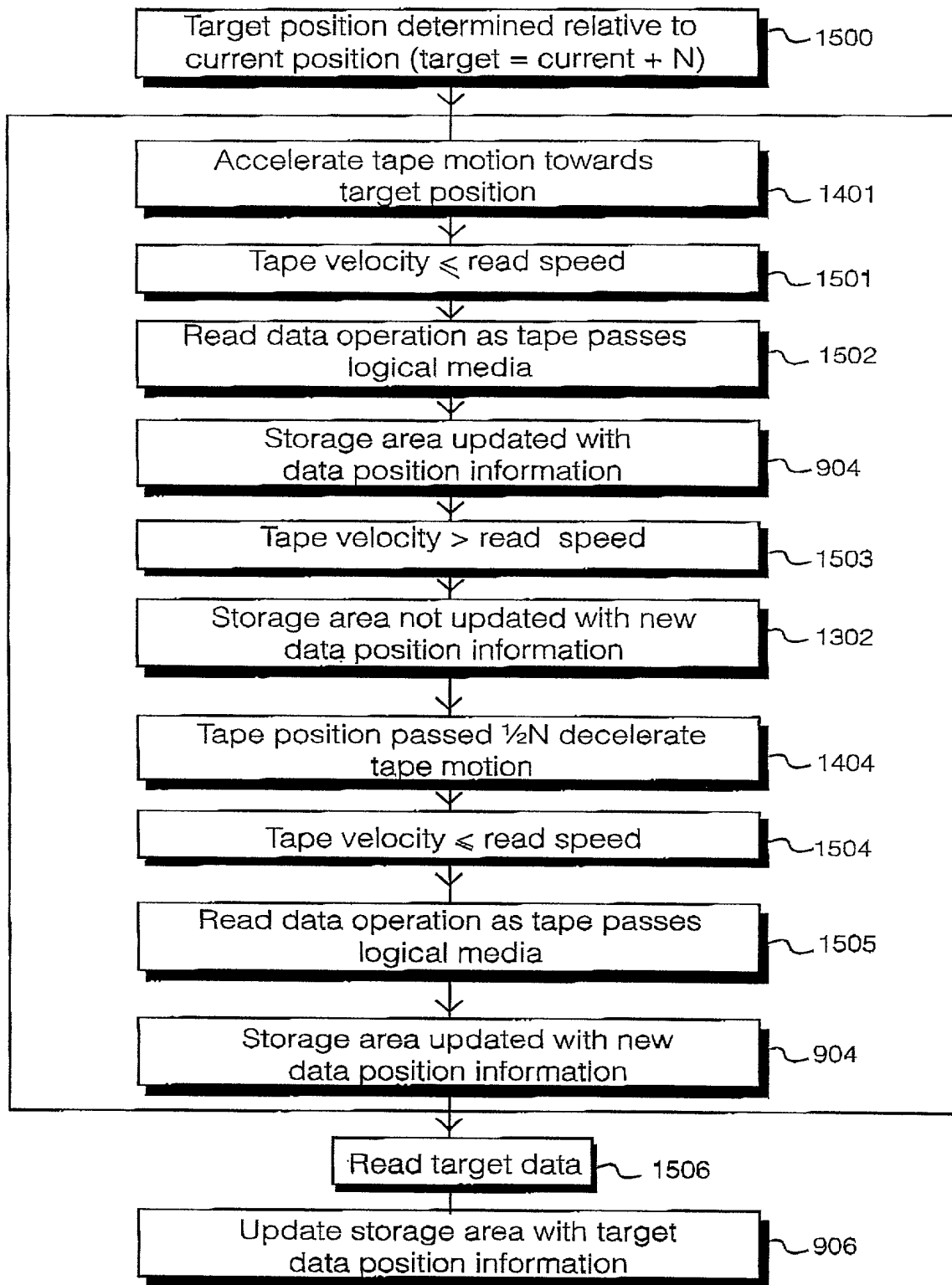

Fig. 15

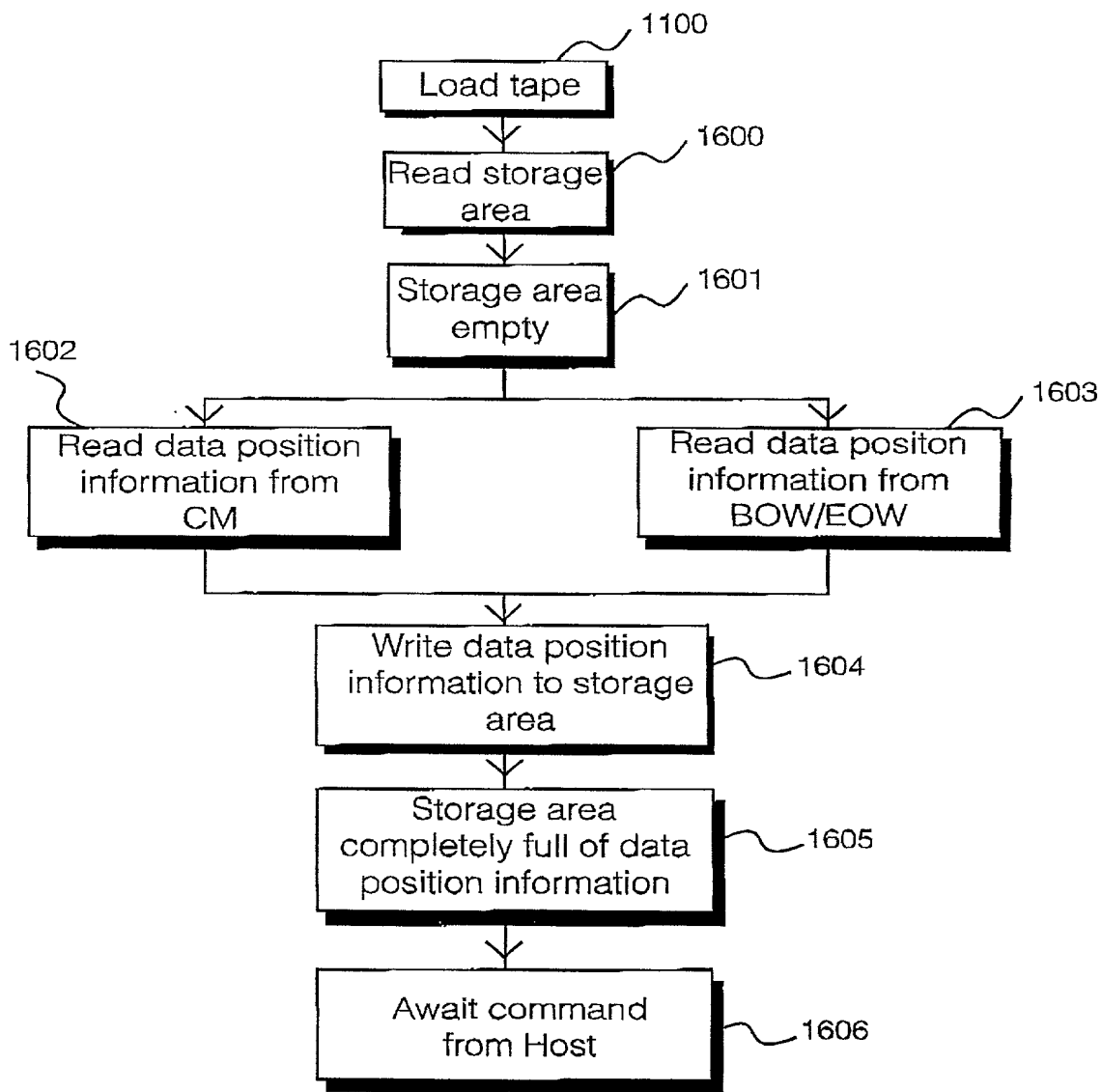

Fig. 16